

Personal Settings - Press the SETTINGS Button

1 Set up Call Forwarding	2 ABC Enable/Disable Do Not Disturb	3 DEF Set Up Memory Speed Dialing
4 GHI Re-Record Greeting, Name and Password	5 JKL	6 MNO Enable/Disable Night Mode
7 PQRS Set Up Call Handling When Not Available	8 TUV	9 WXYZ
* Cancel	0	#

Call Handling When You are Not Available

You can set up your extension for how calls are handled when you're not available to answer. After the specified number of rings, if no one answers, the call is directed to your voice mail.

Use Call Forwarding to:

- Direct calls to another universal extension number.
- Direct calls to an outside telephone number (include 9 for an outside line).

Voice Mail - Press the BIZMAIL Button

1 Play next message	2 ABC Save message	3 DEF Delete message
4 GHI Repeat message	5 JKL	6 MNO Hear message time and date stamp
7 PQRS Play previous message	8 TUV	9 WXYZ Restore deleted messages
* Exit voice mail	0	#

Meeting Rooms and Conference Calls

- Dial 290 to set up or join a telephone Meeting Room. Up to 4 people can join a telephone Meeting Room.

Dial 299 for Bizfon Customer Care

<input type="checkbox"/> TRANSFER	PICKUP <input type="checkbox"/>	
	DND <input type="checkbox"/>	
<input type="checkbox"/> BIZMAIL	PA <input type="checkbox"/>	These keys are not supported in the Product Preview Program.
	SETTINGS <input type="checkbox"/>	
<input type="checkbox"/> CONFERENCE		
	MUTE <input type="checkbox"/>	

1 Reconnect to a call on hold	2 ABC Extensions 201-208	3 DEF
4 GHI	5 JKL	6 MNO
7 PQRS	8 TUV	9 WXYZ Make an outside call
* Help	0 Call Operator	#
<input type="text"/>	<input type="text"/>	<input type="text"/>
HOLD	MEM DIAL	SPEAKER

Feature Phone Reference Card



BizTouch™

Placing and Handling Calls

To make an outside call:

- Press **9**.
- Wait for the dial tone.
- Dial the number.

To put call on hold:

- Press the HOLD button.

To reconnect to a call on hold:

- Press **1**.

To transfer a call:

- Press the TRANSFER button.
- Dial the extension or outside number you want to transfer the call to.
- Hang up or stay on the line to announce the caller and then hang up.

NOTE: You can transfer a call already on hold at any time by pressing the TRANSFER button.

Call Forwarding

To forward calls to another extension or telephone number:

- Press the SETTINGS button to enter Personal Settings.
- Press **1** to enter Call Forwarding.
- Enter the extension or outside number to which you want to forward your calls.

To put a call on hold and Pick Up the call at another telephone:

- Press HOLD to put the call on hold and then hang up.
- Go to the extension where you want to speak to the person on hold.
- Press the PICK UP button.
- Dial the extension that has the call on hold.

Do Not Disturb:

To route calls directly to your voice mail, press the Do Not Disturb button.

Setting Up Memory Speed Dial:

You can program speed dial numbers into memory so that you only have to enter a one-digit number to call an extension or outside number.

To set up speed dial numbers, do the following:

- Press the SETTINGS button to enter Personal Settings.
- Press **3** to set up Speed Dial.
- Follow the prompts.

Emergency use:



- Press **9**.
- Wait for the dial tone.
- Dial 911 or the emergency number.

Setting Up or Changing your Password

You don't have to choose a password, but if you don't, anyone can listen to your voice mail or change your personal settings from your telephone. Also, without a password, you are unable to use your extension from outside the office.

Passwords must be from 3 to 10 digits. To protect your privacy, you should not share your password with other people.

To set up or change your password:

- Press the SETTINGS button to enter Personal Settings.
- Press  to select Change Greeting, Password or Recorded Name.
- Press  to select Change Your Password.
- Follow the prompts to change your password.



Recording a Personal Greeting

You can record a personal greeting that callers hear before they leave voice mail. If you don't record a personal greeting, callers hear "You have reached the voice mailbox of <your recorded name>."

Tips for writing your greeting:

- Write down what you plan to say.
- Read the greeting aloud before recording it to be sure you like the way it sounds.
- You can tell callers that they can press the # key in the future to skip your greeting.



To record your greeting:

- Press the SETTINGS button to enter Personal Settings.
- Press  to select Change Greeting, Password or Recorded Name.
- Press  to select Change Your Greeting.
- Follow the prompts to change your Greeting.

Changing your Recorded Name

You can change your recorded name, the name that callers hear when the System Greeting presents the list of extensions.

To change your recorded name:

1. Press the SETTINGS button to enter Personal Settings.
2. Enter your extension number or password.
3. Press  to select Change Greeting, Password or Record Name.
4. Press  to select Change Your Recorded Name.
5. Follow the prompts to change your recorded name.

Notification

When you pick up your telephone handset, the system tells you:

- How many new voice mail messages you have
- If you have a call on hold
- If Do Not Disturb is on
- If Call Forwarding is on
- If Night Mode is on

Using Your Bizfon from Outside the Office

To use your Bizfon from outside of the office:

1. Dial your company's phone number.
2. Press  during the greeting.
3. Enter your extension and password as instructed by the prompts.
4. Refer to the Bizfon 680 Wallet Card for more information.

Bizfon, Inc.

50 Stiles Rd.
Salem, NH 03079

Phone: (603) 870-9400
Fax: (603) 870-9250
Customer Care: Dial Ext. 299
www.bizfon.com

© Copyright 2005 Bizfon, Inc.
Bizfon, BizTouch and the Bizfon logo are trademarks of Bizfon, Inc.
All other trademarks are held by their respective owners.

PN: 050-00012:B

Using BizTouch Controls

VOLUME CONTROLS

Slide the **SPEAKER** control to adjust the speaker volume.

Use the **RINGER** switch to adjust the ring volume.

Use the **HANDSET** volume switch to adjust the handset volume.

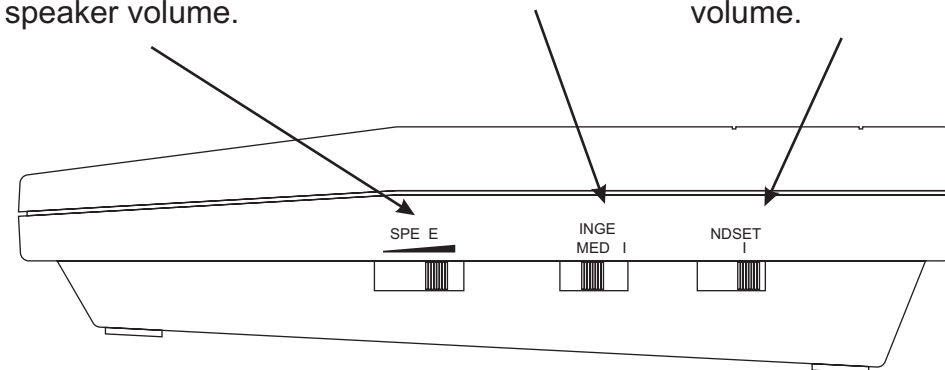

Using the MUTE Button

Press the MUTE button to turn off the microphone for both the speakerphone and the handset, so that the caller on the other end of the line cannot hear anything you say. Press it again to turn the microphone back on.

Using the MEM DIAL Button

The MEM DIAL button enables you to dial telephone numbers that you have previously programmed in memory. See *Setting Up Memory Speed Dial* for information on programming numbers into memory.

- Press the MEM DIAL button.
- Press the digit associated with the number stored in memory.

Internal and External Rings

When an internal caller is calling, you hear a single ring.

When an outside caller is calling, you hear two short rings.

Using the Speakerphone

Making a hands-free call:

- Press the SPEAKER button and wait for dial tone.
- Adjust volume if needed.
- Press the SPEAKER button again to hang up the phone.

Receiving a call:

- Press the SPEAKER button instead of picking up the handset when the phone rings.
- Adjust volume if needed.
- Press SPEAKER button again to hang up the phone.

Switching between Speaker and Handset:

You can switch between speakerphone and handset while the phone is dialing a number, or anytime during a conversation.

- Speaker to Handset: Pick up the handset.
- Handset to Speaker: Press SPEAKER, then hang up handset.
- **NOTE:** Be sure to press the SPEAKER button before hanging up the handset or you will hang up on the call.

For best speakerphone performance avoid the following:

- Areas with high background noise (the microphone might pick up these sounds and prevent the speakerphone from going into the receiving mode when you finish talking).
- Surfaces affected by vibration.
- Recessed areas such as in a corner or next to a cabinet, which can generate an echo effect.

Note the following guidelines when using the speakerphone:

- The speakerphone works similar to a two-way radio in that you can only listen or talk at one time.
- Stay reasonably close to the phone so that you can be clearly heard by the person to whom you are talking.
- You can adjust the speaker volume by sliding the SPEAKER control on the right side of the telephone.
- The speakerphone indicator light comes on when the speakerphone is in use.